

Paper Feed Unit Type 2600

(Code: G555)

For Machine Code: G056/G058/G073/G074/G091

INSTALLATION GUIDE

⚠ Caution

- Before installing options, the machine should be turned off and unplugged for at least thirty minutes. Components inside the machine become very hot, and can cause a burn injury if touched.
- When lifting the machine, use the grips on both sides. The machine could break or cause an injury if dropped.
- It is dangerous to handle the plug with wet hands. Doing this may result in receiving an electric shock.
- Before moving the machine, unplug the power cord from the outlet. If the cord is unplugged abruptly, it could become damaged. Damaged plugs or cords can cause an electrical or fire hazard.

🔍 Important

- Do not slide more than one paper tray out at a time. Having more than one paper tray filled with paper in a fully extended position could cause the machine to fall down.
- Do not attach more than two Paper Feed Units in your printer at the same time.
- If you attach two Paper Feed Units at the same time, stack them up in advance.
- Check the printer nameplate to confirm the model code.

1 Check the contents of the box for the following items:

Description	Qty
Paper Feed Unit (including a paper tray)	1
Installation Guide (This sheet)	1

2 Confirm that the followings are true:

- The power switch is turned off.
- The power cord is unplugged from the wall outlet.

3 Remove the adhesive tape from the Paper Feed Unit.

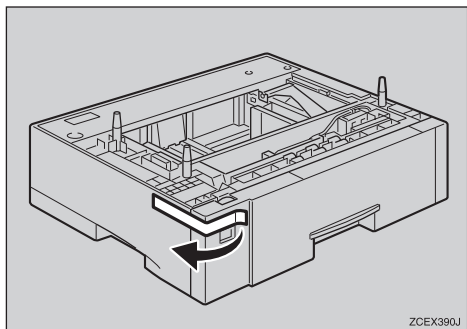

📌 Note

- If you install two Paper Feed Units at a time, stack them up in advance.

4 There are three pins on the top of the Paper Feed Unit that point straight up. On the bottom of the printer there are three holes. Align the holes over the pins and lower the printer gently onto the Paper Feed Unit.

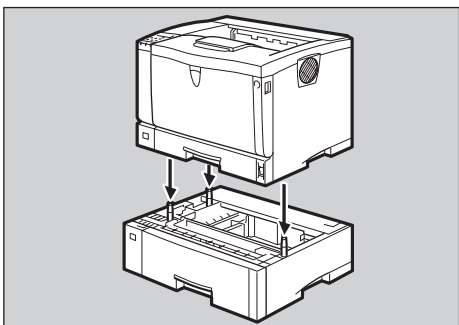

⚠ Caution

- When lifting the machine, use the inset grips on both sides. Otherwise the machine could break or cause injury if dropped.

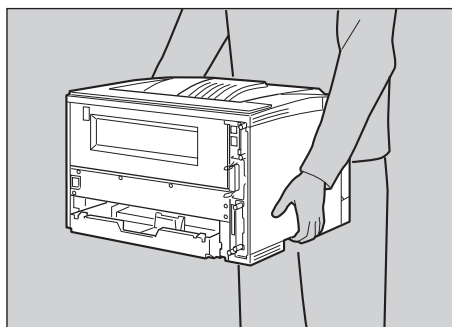

5 Attach the interface cable to the printer.

6 Plug the printer's power cord back into the wall outlet and turn on the power switch.

🔍 Reference

- For information about loading paper, see "Loading Paper in the *Optional Paper Tray*" in the Printer Reference provided as a PDF file on the CD-ROM labeled "Operating Instructions".